

AIPHONE

DB Series



Hands-free Two-Wire Electric Lock Door Phone



Audio Door Entry You Can Count On

Easy to install and simple to use, the DB Series protects private homes and apartments. For an ideal audio door entry solution, use Aiphone's DB Series !



Hands-Free Communication in Any Place

With the DB Series' compact design, it can fit anywhere in your home. Convenient hands-free communication is convenient for anyone to use.



Up to 5 Inside Stations With Room-to-Room Communication

Unable to answer your door from the Master station? No problem! Talk with visitors from anywhere in your home with up to 4 additional Sub master stations. Inside stations can be used for room-to-room communication.



Call multiple inside stations at the same time for room-to-room communication.



Option Button

Use the Option button to control an external device, such as an entrance light.



Chime Sound

Just a press of the Call button of Door station rings the chime continuously for appropriate time (approximately 4 seconds).

2-Wire System for Simple Installation

With the easy to install two-wire system, use the DB Series to replace your door bell.



System Configuration

For Private Homes

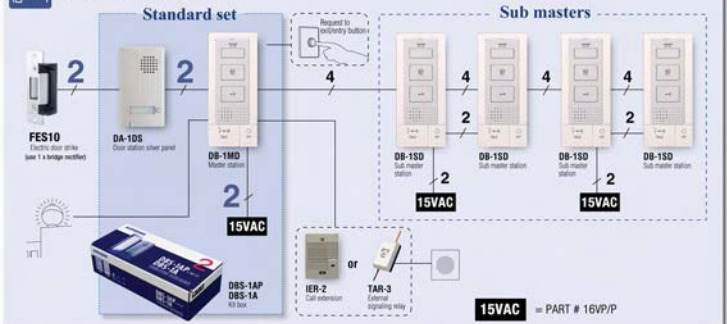

For Apartment Blocks

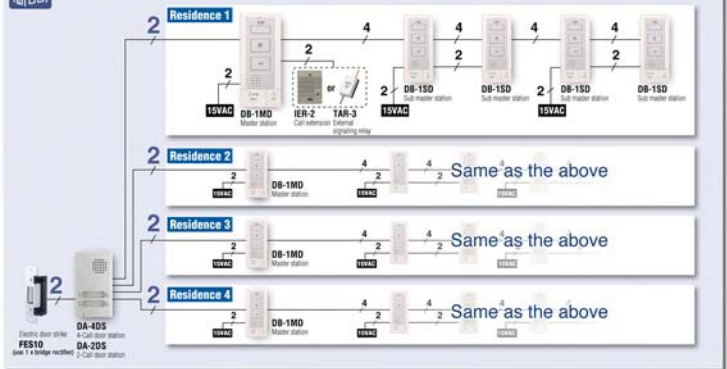

DB Series

Line up



DA-1DS
Door station silver panel



DA-2DS
2-Call door station



DA-4DS
4-Call door station



DB-1MD
Master station



DB-1SD
Sub master station



16VP/P
AC transformer

Boxed set



DBS-1AP :
DB-1MD, DA-1DS, PT-1211DR

DBS-1A :
DB-1MD, DA-1DS, PT-1211C or PT-1211D



IER-2
Call extension



FES10
Electric door strike



TAR-3
External signaling relay



AC-10S
Vandal resistant access control keypad, surface mount



AC-10F
Vandal resistant access control keypad, flush mount



DAW-P
Door station mounting plate (83.5mm)

Unit dimensions (mm)

DA-1DS

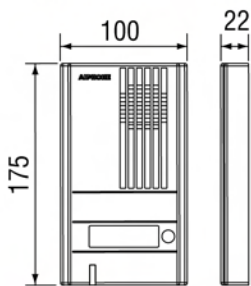

DA-2DS/4DS

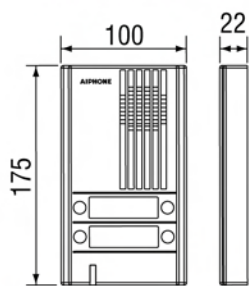

DB-1MD/1SD

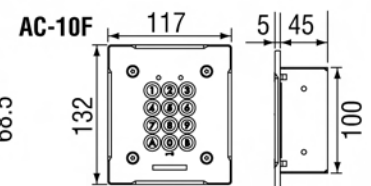
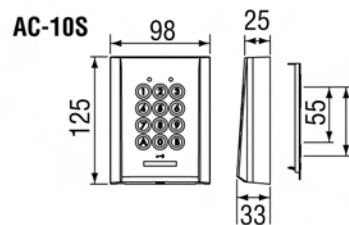
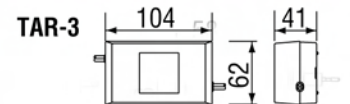
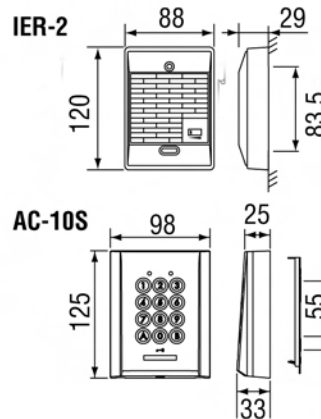
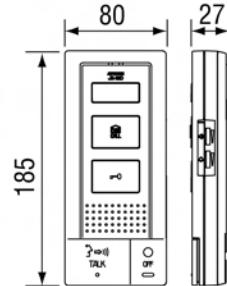

Features

- Two-wire system including door release
- Door release wired to door station, requiring no power transformer
- Total hands-free communication, auto-voice actuation
- Press-to-talk operation available
- User-optional function button
- Call tone MUTE with indicator
- Call extension sounder

Specifications

Power source	15V AC
AC transformer	16VP/P
Communication	Approx. 1 min. AUTOMATIC (Hands-free); To activate, momentarily press TALK button. MANUAL (Press-to-talk/Release-to-listen); To activate, press TALK button for 1 sec. or more.
Door release	FES10 + 1 x Bridge Rectifier (Part# BR)
Option contact (AC/DC)	Voltage Max. : 24V, Min. : 1V Current Max. : 1.6A, Min. : 10mA
Wiring	2 wires, throughout AC trans - Master - Door - Door release
Distance	Door rlse. 110m(0.6mmØ) 200m(0.8mmØ) 310m(1.0mmØ) DB-1MD 55m(0.6mmØ) 100m(0.8mmØ) 155m(1.0mmØ) DB-1MD ~ farthest DB-1SD 100m(0.6 ~ 1.0mmØ)

Caution

When existing chime wires are used, it is possible they contain AC voltage. Electric shock or unit damage could result. Ask a qualified electrician for more details.

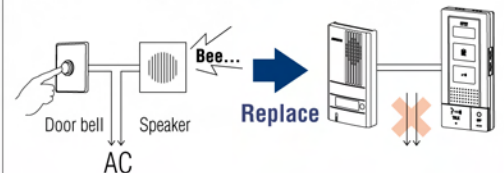

Distributed by :

LAPS
LOCAL AREA PROTECTIVE SERVICES
1300 450 650

Deming Prize



Deming Medal

ISO 9001



ISO 9001 Certified
JQA-0291
AIPHONE CO., LTD.

ISO 14001



ISO 14001 Certified
JQA-EM0453
Headquarters section
Toyota Factory
Taiboh Site
AIPHONE CO., LTD.

AIPHONE[®]
Providing Peace of Mind

<http://www.aiphone.net/>

Printed in Japan (E)
MA52004AYZ